

تم تحميل وعرض المادة من منصة

حقيبتك

www.haqibati.net



منصة حقيبتك التعليمية

منصة حقيبتك هو موقع تعليمي يعمل على تسهيل العملية التعليمية بطريقة بسيطة وسهلة وتوفير كل ما يحتاجه المعلم والطالب لكافة الصفوف الدراسية كما يحتوي الموقع على حلول جميع المواد مع الشروح المتنوعة للمعلمين.

Super Goal 3

Worksheet unit 5

Name :

Class:.....

Grammar

❖ Choose the best answer to fill in the blank in each question.

3 Marks

- We _____ friends since first grade.
a. has been b. have been c. been d. being
- I have had my new car _____ September.
a. since b. for c. are d. none
- A thief stole my bike my bike was _____.
a. steel b. steeling c. stolen d. stole

❖ complete the sentences with for or since:

3 Marks

- Nora has had the same TV _____ 15 years.
- I have had my laptop _____ last June.
- We have worked on this project _____ a month

Vocabulary



❖ Choose the best answer to fill in the blank in each question.

3 Marks

- 'Digital' is a word that relates to _____.
a. technology b. history c. playing d. shopping
- I cooked the burgers on the _____.
a. radio b. printer c. stove d. watch
- Hanan needs paper for the _____.
a. stove b. radio c. printer d. microwave

❖ Match.

3 Marks

1	bicycle	2	camera	3	stove
A		B		C	

Orthography

❖ Choose the correct letter.

3 Marks

- He buys a new compu...er
a. (p) b. (t) c. (m)
- I am watching televisi....n
a. (o) b. (f) c. (q)
- Hi. This is a surp....ise !
a. (h) b. (p) c. (r)

Name :

Class:.....

Grammar

❖ Choose the best answer to fill in the blank in each question.

- We _____ friends since first grade.
 - has been
 - have been**
 - been
 - being
- I have had my new car _____ September.
 - since**
 - for
 - are
 - none
- A thief stole my bike my bike was _____.
 - steel
 - steeling
 - stolen**
 - stole

3 Marks

❖ complete the sentences with **for** or **since**:

- Nora has had the same TV **for** 15 years.
- I have had my laptop **since** last June.
- We have worked on this project **for** a month

3 Marks

Vocabulary



❖ Choose the best answer to fill in the blank in each question.

- 'Digital' is a word that relates to _____.
 - technology**
 - history
 - playing
 - shopping
- I cooked the burgers on the _____.
 - radio
 - printer
 - stove**
 - watch
- Hanan needs paper for the _____.
 - stove
 - radio
 - printer**
 - microwave

3 Marks

❖ Match.

3 Marks

1	bicycle	2	camera	3	stove
A		B		C	
 stove camera bicycle

Orthography

❖ Choose the correct letter.

- He buys a new compu...er
 - (p)
 - (t)**
 - (m)
- I am watching televisi....n
 - (o)**
 - (f)
 - (q)
- Hi. This is a surp....ise !
 - (h)
 - (p)
 - (r)**

3 Marks

Name : Class:.....

Grammar

6 Marks

❖ Choose the best answer to fill in the blank in each question.

- We _____ friends since first grade.
a. has been b. have been c. been d. being
- They _____ on the phone for two weeks.
a. not has talked b. not have talked c. hasn't talked d. haven't talked
- I have had my new car _____ September.
a. since b. for c. are d. none
- He has been studying Arabic _____ six months.
a. are b. for c. since d. none
- A thief stole my bike my bike was _____ .
a. steel b. steeling c. stolen d. stole
- The boys broke the window the window was _____ by the boys .
a. broken b. break c. breaking d. broke

❖ complete the sentences with for or since:

3 Marks

- Nora has had the same TV _____ 15 years.
- I have had my laptop _____ last June.
- We have worked on this project _____ a month

Vocabulary

❖ Choose the best answer to fill in the blank in each question.

6 Marks

- 'Digital' is a word that relates to _____.
a. technology b. history c. playing d. shopping
- I cooked the burgers on the _____.
a. radio b. printer c. stove d. watch
- I got a new job ! _____.
a. Settle down b. Congratulations c. Long time no see. d. hello
- 'Interrupted' means _____.
a. fast b. good c. fly d. stopped
- " pretty " means _____.
a. cold b. very c. problem d. happy
- Hanan needs paper for the _____.
a. stove b. radio c. printer d. microwave

❖ Write the correct word under the picture.

3 Marks



Credit card – Camera - Printer



.....

❖ Choose the correct letter.

2 Marks

- He buys a new compu....er (o – y – t)
- I am watching televisi....n (o – g – v)

Name : Class:.....

Grammar

6 Marks

❖ Choose the best answer to fill in the blank in each question.

- We _____ friends since first grade.
a. has been b. **have been** c. been d. being
- They _____ on the phone for two weeks.
a. not has talked b. not have talked c. hasn't talked d. **haven't talked**
- I have had my new car _____ September.
a. **since** b. for c. are d. none
- He has been studying Arabic _____ six months.
a. are b. **for** c. since d. none
- A thief stole my bike my bike was _____.
a. steel b. steeling c. **stolen** d. stole
- The boys broke the window the window was _____ by the boys .
a. **broken** b. break c. breaking d. broke

❖ complete the sentences with **for** or **since**:

3 Marks

- Nora has had the same TV **for** 15 years.
- I have had my laptop **since** last June.
- We have worked on this project **for** a month

Vocabulary

❖ Choose the best answer to fill in the blank in each question.

6 Marks

- 'Digital' is a word that relates to _____.
a. **technology** b. history c. playing d. shopping
- I cooked the burgers on the _____.
a. radio b. printer c. **stove** d. watch
- I got a new job ! _____.
a. Settle down b. **Congratulations** c. Long time no see. d. hello
- 'Interrupted' means _____.
a. fast b. good c. fly d. **stopped**
- " pretty " means _____.
a. cold b. **very** c. problem d. happy
- Hanan needs paper for the _____.
a. stove b. radio c. **printer** d. microwave

❖ Write the correct word under the picture.

3 Marks

Credit card – Camera - Printer



Printer

Credit card

Camera

❖ Choose the correct letter.

2 Marks

- He buys a new compu....er (o - y - t)
- I am watching televisi....n (o - g - v)

لعل
رشد السليم

Match a word in Column 1 with a word in Column 2.

<i>Column 1</i>	<i>Column 2</i>
1. digital	A. phone
2. cellular	B. camera
3. laptop	C. oven
4. high-tech	D. computer
5. microwave	E. printer

Choose the best answer to fill in the blank.

6. The newest laptops are _____.
 A. clumsy
 B. light
 C. huge
 D. conventional

7. The first computer was _____.
 A. light
 B. fast
 C. conventional
 D. huge

Write *for* or *since* to fill in the blank.

8. I have had my new car _____ September.
 9. He has been studying Arabic _____ six months.
 10. They have played tennis together _____ five years.
 11. We haven't gone to the beach _____ last summer.

Complete the question.

12. **Larry:** _____ played tennis?
Brad: I've played tennis for three years.

13. **Nura:** _____ to Abu Dhabi?
Emily: No, I haven't been there.

Choose the best answer to fill in the blank.

14. We _____ friends since first grade.
 A. has been
 B. have been
 C. been
 D. being

15. They _____ on the phone for two weeks.
 A. not has talked
 B. not have talked
 C. hasn't talked
 D. haven't talked

Write the sentence in the passive.

25. Tim Berners-Lee invented the World Wide Web.
-

26. London has hosted the Olympic Games three times.
-

27. More than 340 million people around the world speak Arabic.

Reading

The Ballpoint Pen

Ballpoint pens have not been around for very long. John Loud invented the first ballpoint pen in 1888. Before the invention of ballpoint pens, people had to dip their pens into ink when they were writing. This made writing slow. Also, sometimes too much ink made the writing messy. Ballpoint pens were the first pens that did not need to be dipped in ink.

Loud's invention was wonderful, but the design was still not perfect. Sometimes the pen did not get enough ink, and sometimes it got too much ink. Other inventors continued to work on the design of the ballpoint pen to improve it. For the next 30 years, inventors created over 350 kinds of ballpoint pens. But still the pens did not work very well, and people did not buy them.

It wasn't until 1935 that Ladislav Biro and his brother developed an improved ballpoint pen in Hungary. Today, in the U.K. and Australia, some people call ballpoint pens *biros* after their inventor.

16. Ballpoint pens have been around since _____.

- A. 1800
- B. 1888
- C. 1910
- D. 1935

17. Before ballpoint pens, writers had to _____.

- A. use their fingers
- B. use pencils
- C. dip their pens into ink
- D. dip their pens into water

18. The problem with Loud's invention was _____.

- A. it was too heavy
- B. it didn't work during the day
- C. it didn't always get the right amount of ink
- D. it was too expensive

19. Some British people call ballpoint pens _____.

- A. louds
- B. pencils
- C. inks
- D. biros

20. People have been using ballpoint pens for _____.

- A. over 100 years
- B. less than 100 years
- C. 1888
- D. 1935

Super Goal 3

Worksheet unit 6

Name :

Class:

Grammar

❖ Choose the best answer to fill in the blank in each question.

3 Marks

- This ring is _____ in the shop.
a. a. the expensivest b. more expensive c. the most expensive d. expensive
- In Europe, August is _____ than February.
a. hot b. hotter c. hottest d. hottest are
- Our neighborhood isn't _____ our old one.
a. as noisy as b. as noisy c. noisy as d. noisy

❖ Write a or an or the to fill in the blank:

3 Marks

- I bought _____ new TV set yesterday.
- Are you coming to _____ party next Saturday?
- He is _____ engineer.

Vocabulary



❖ Choose the best answer to fill in the blank in each question.

3 Marks

- _____ are green areas.
a. Buildings b. Roads c. Parking lots d. Parks
- An apartment is a type of _____ .
a. recreation b. transportation c. housing d. hospital
- Efficient buses are always _____ .
a. punctual b. cozy c. late d. dangerous

❖ Match.

3 Marks

1	train	2	pasta	3	bus
A		B		C	

Orthography

❖ Choose the correct letter.

3 Marks

- Bus tic...et is expensive
a. (m) b. (k) c. (b)
- The trains in Japan tra....el at a speed faster than sound
a. (d) b. (n) c. (v)
- Rome is an amazing ci...y and so is Paris
a. (t) b. (w) c. (a)

Name :

Class:.....

Grammar

❖ Choose the best answer to fill in the blank in each question.

3 Marks

- This ring is _____ in the shop.
a. a. the expensivest b. more expensive c. **the most expensive** d. expensive
- In Europe, August is _____ than February.
a. hot b. **hotter** c. hottest d. hottest are
- Our neighborhood isn't _____ our old one.
a. **as noisy as** b. as noisy c. noisy as d. noisy



❖ Write a or an or the to fill in the blank:

3 Marks

- I bought a new TV set yesterday.
- Are you coming to the party next Saturday?
- He is an engineer.

Vocabulary



❖ Choose the best answer to fill in the blank in each question.

3 Marks

- _____ are green areas.
a. Buildings b. Roads c. Parking lots d. **Parks**
- An apartment is a type of _____ .
a. recreation b. transportation c. **housing** d. hospital
- Efficient buses are always _____ .
a. **punctual** b. cozy c. late d. dangerous

❖ Match.

3 Marks

1	train	2	pasta	3	bus
A		B		C	
	<u>pasta</u>		<u>bus</u>		<u>train</u>

Orthography

❖ Choose the correct letter.

3 Marks

- Bus tic...et is expensive
a. (m) b. **(k)** c. (b)
- The trains in Japan tra....el at a speed faster than sound
a. (d) b. (n) c. **(v)**
- Rome is an amazing ci...y and so is Paris
a. **(t)** b. (w) c. (a)

Name : Class:.....

Grammar

6 Marks

❖ Choose the best answer to fill in the blank in each question.

- This ring is _____ in the shop.
a. a. the expensivest b. more expensive c. the most expensive d. expensive
- In Europe, August is _____ than February.
a. hot b. hotter c. hottest d. hottest are
- Trains are _____ planes.
a. As expensive as b. As expensive c. expensive as d. none
- Our neighborhood isn't _____ our old one.
a. as noisy as b. as noisy c. noisy as d. noisy
- The subway is _____ during the day than at night.
a. crowded b. more crowded c. the most crowded d. crowed more
- He is a tourist. _____ tourist is in Jeddah.
a. A b. An c. The d. none

❖ Write a or an or the to fill in the blank:

3 Marks

- I bought _____ new TV set yesterday.
- Are you coming to _____ party next Saturday?
- He is _____ engineer.

Vocabulary

❖ Choose the best answer to fill in the blank in each question.

6 Marks

- A bus, a train, and a taxi are all kinds of _____.
a. air quality b. public transportation c. crime rate d. culture and recreation
- _____ are green areas.
a. Buildings b. Roads c. Parking lots d. Parks
- An apartment is a type of _____.
a. recreation b. transportation c. housing d. hospital
- A safe city has a low _____.
a. crime rate b. cost of housing c. air quality d. public transportation
- Efficient buses are always _____.
a. punctual b. cozy c. late d. dangerous
- _____ is The bride of the red sea.
a. Riyadh b. Dammam c. Hail d. Jeddah

❖ Write the correct word under the picture.

3 Marks

Traffic – Airplane - Train



.....



.....



.....

❖ Choose the correct letter.

2 Marks

- Green Are..... (o – a – t)
- Bus tic...et is expensive (k – g – v)

Name : Class:.....

Grammar

6 Marks

❖ Choose the best answer to fill in the blank in each question.

- This ring is _____ in the shop.
a. a. the expensivest b. more expensive c. **the most expensive** d. expensive
- In Europe, August is _____ than February.
a. hot b. **hotter** c. hottest d. hottest are
- Trains are _____ planes.
a. **As expensive as** b. As expensive c. expensive as d. none
- Our neighborhood isn't _____ our old one.
a. **as noisy as** b. as noisy c. noisy as d. noisy
- The subway is _____ during the day than at night.
a. crowded b. **more crowded** c. the most crowded d. crowed more
- He is a tourist. _____ tourist is in Jeddah.
a. A b. An c. **The** d. none

❖ Write a or an or the to fill in the blank:

3 Marks

- I bought a new TV set yesterday.
- Are you coming to the party next Saturday?
- He is an engineer.

Vocabulary

❖ Choose the best answer to fill in the blank in each question.

6 Marks

- A bus, a train, and a taxi are all kinds of _____.
a. air quality b. **public transportation** c. crime rate d. culture and recreation
- _____ are green areas.
a. Buildings b. Roads c. Parking lots d. **Parks**
- I An apartment is a type of _____.
a. recreation b. transportation c. **housing** d. hospital
- A safe city has a low _____.
a. **crime rate** b. cost of housing c. air quality d. public transportation
- Efficient buses are always _____.
a. **punctual** b. cozy c. late d. dangerous
- _____ is The bride of the red sea.
a. Riyadh b. Dammam c. Hail d. **Jeddah**

❖ Write the correct word under the picture.

3 Marks

Traffic – Airplane - Train



..... **Airplane**



..... **Train**



..... **Traffic**

❖ Choose the correct letter.

2 Marks

- Green Are..... (o - **a** - t)
- Bus tic...et is expensive (**k** - g - v)

لعل
رشد السليم

Choose the best answer to fill in the blank.

1. A bus, a train, and a taxi are all kinds of _____.

- A. air quality
- B. public transportation
- C. crime rate
- D. culture and recreation

2. _____ are green areas.

- A. Buildings
- B. Roads
- C. Parking lots
- D. Parks

3. An apartment is a type of _____.

- A. recreation
- B. transportation
- C. housing
- D. hospital

4. A safe city has a low _____.

- A. crime rate
- B. cost of housing
- C. air quality
- D. public transportation

5. Efficient buses are always _____.

- A. punctual
- B. cozy
- C. late
- D. dangerous

6. Cost of living and housing are _____ indicators.

- A. public transportation
- B. green area
- C. air quality
- D. quality of life

7. Commuters worry about the amount of _____.

- A. traffic
- B. hospitals
- C. schools
- D. recreation

Write the correct form of the adjective in parentheses to fill in the blank.

8. Our town has the _____ water of all the towns in this area. (clean)

9. Traffic in big cities is _____ than it is in smaller towns. (bad)

10. This gas station has the _____ gas in town. (cheap)

11. The mall is the _____ place on Saturday afternoons. (crowded)

Choose the underlined article that is incorrect in each sentence.

25. Some people say that you can see the Great Wall of the China from the moon, but that's just a myth.

- A. the Great Wall
- B. the China
- C. the moon
- D. a myth

26. The New York isn't the capital, but it is the largest city in the United States.

- A. The New York
- B. the capital
- C. the largest
- D. the United States

27. In the morning, he has a shower, eats the breakfast, and then takes the bus to work.

- A. the morning
- B. a shower
- C. the breakfast
- D. the bus

Write a sentence with *as...as*.

12. The blue chair is comfortable. The red chair is comfortable.

Rewrite the question as an indirect question with *Do you know*.

13. What's the name of the town?

14. Where is the nearest hospital?

Rewrite the question as an indirect question with *Could you tell me*.

15. where does he work ?

Question type: True/False

For Rent

1. Large, two-bedroom apartment on safe, quiet street. Two blocks from train station. Near park. \$800 a month. Call 701-555-7847.

2. Small room near university. Fully furnished. Perfect for male, single student. Fully-equipped kitchen available. Parking available. \$300 a month. Call 823-555-4865.

3. Studio apartment, excellent location. One block from city center, close to restaurants, a sports center, and public transportation. Call 701-555-2532.

16. These are housing ads. ()

17. The studio apartment is fully furnished. . ()

18. The two-bedroom apartment is near public transportation. . ()

19. The studio apartment is in a quieter location than the two-bedroom apartment. . ()

20. The studio apartment is close to recreation. . ()

Name:

Ms. Tahani 慧

Class: 3rd Intermediate

Revision Sheet _ Unit (6) : Do You Know Where It Is?

I. Vocabulary:

A- Write the words under the pictures:

bullet train – bridge – commuters – fountain - suburb



B- Classify the words:

crime rate – taxis – kilometres

Vehicle	Measurement words	Features of town

C- Circle the odd word:

1- Vehicle: car – stadium – bus – taxi

2- Features of town: green area – cost of housing – clean air – mile

D- Match:

1- run down

a- holds

2- consecutive

b- an unbroken series

3- leading

c- in needed of fixing / not looked after

4- combination

d- popular

e- mixture

E- Fill in the blank with the correct words in the box:

renovate – fare – survey – efficient – transportation

1- There is public available throughout the city.

2- The questions were not very clear.

3- The homeowners decided to their old kitchen.

4- Ali is very at his job.

F- Match the word with its opposite:

1- narrow

a- high

2- low

b- cheap

3- polluted

c- wide

4- cozy

d- uncomfortable

e- clean

II. Grammar:

A- Choose:

- 1- Fadi is (**tall – taller – tallest**) .
- 2- Hatem is (**tall – taller – tallest**) than Samer.
- 3- Rama is the (**tall – taller – tallest**) student in the class.
- 4- The chair is (**comfortable – more comfortable – most comfortable**).
- 5- The sofa is (**comfortable – more comfortable – most comfortable**) than the chair.
- 6- The bed is the (**comfortable – more comfortable – most comfortable**) furniture.
- 7- Leen’s marks are (**good – better – best**) than her friend.
- 8- Dammam has the (**bad – worse – worst**) weather in Saudi Arabia.
- 9- Your sister is as (**smart – smarter – smartest**) as you.
- 10-Your mobile (**is not as – is as not – not is as**) new as mine.
- 11- (**A – An – The**) sun rises in the east and sets in the west.
- 12- The bird is flying in (**the – a – an**) sky.

B- Do as shown between brackets:

- | | |
|--|--------------------------|
| 1- Where is the supermarket?
..... | (Make indirect question) |
| 2- When does the shop open?
..... | (Make indirect question) |
| 3- Wafa’s hair is <u>long</u> than Faten’s.
..... | (Correct the mistake) |
| 4- Dana is in the Jeddah on vacation.
..... | (Correct the mistake) |

Super Goal 3

Worksheet unit 7

Name :

Class:.....

Grammar

❖ Choose the best answer to fill in the blank in each question.

3 Marks

- Your name is Rashed Alsulami, _____. (Negative Tag)
 - isn't it?
 - is it
 - aren't it ?
 - are it ?
- He _____ play basketball today because he hurt his hand.
 - won't be able to
 - be able
 - able be
 - be able be
- Faris:** What should we do this weekend? - **Hameed:** _____ our bikes to the beach.
 - We could ride
 - Let's riding
 - We should to ride
 - Why we don't ride

❖ Complete the tag question:

- He bought a hammer, _____?
- This old car is in good condition, _____?
- We're buying a lot of stuff, _____?

3 Marks

Vocabulary



❖ Choose the best answer to fill in the blank in each question.

- What do you use to climb a wall ?
 - a ladder
 - a bike
 - a hammer
 - a car
- What do you use to water the garden ?
 - a garage
 - a plate
 - a hose
 - a phone
- What do you use to clean the living room ?
 - a ladder
 - a sofa
 - a vacuum cleaner
 - a TV

3 Marks

❖ Match.

3 Marks

1	twins	2	hammer	3	Printing press
A		B		C	

Orthography

❖ Choose the correct letter.

- These toys are in good con....ition.
 - (n)
 - (m)
 - (d)
- She found a set of nice crystal gla...ses.
 - (t)
 - (s)
 - (h)
- This is the story of an ama....ing coincidence.
 - (p)
 - (f)
 - (z)

3 Marks

Super Goal 3

Worksheet unit 7

Name :

Class:.....

Grammar

❖ Choose the best answer to fill in the blank in each question.

3 Marks

- Your name is Rashed Alsulami, _____ . (Negative Tag)
 - isn't it?
 - is it
 - aren't it ?
 - are it ?
- He _____ play basketball today because he hurt his hand.
 - won't be able to
 - be able
 - able be
 - be able be
- Faris:** What should we do this weekend? - **Hameed:** _____ our bikes to the beach.
 - We could ride
 - Let's riding
 - We should to ride
 - Why we don't ride

❖ Complete the tag question:

- He bought a hammer, _____ **didn't he** _____ ?
- This old car is in good condition, _____ **isn't it** _____ ?
- We're buying a lot of stuff, _____ **aren't we** _____ ?

3 Marks

Vocabulary



❖ Choose the best answer to fill in the blank in each question.

- What do you use to climb a wall ?
 - a ladder
 - a bike
 - a hammer
 - a car
- What do you use to water the garden ?
 - a garage
 - a plate
 - a hose
 - a phone
- What do you use to clean the living room ?
 - a ladder
 - a sofa
 - a vacuum cleaner
 - a TV

3 Marks

❖ Match.

3 Marks

1	twins	2	hammer	3	Printing press
A		B		C	
 hammer Printing press twins

Orthography

❖ Choose the correct letter.

- These toys are in good con....ition.
 - (n)
 - (m)
 - (d)
- She found a set of nice crystal gla...ses.
 - (t)
 - (s)
 - (h)
- This is the story of an ama....ing coincidence.
 - (p)
 - (f)
 - (z)

3 Marks

Super Goal 3

Worksheet unit 8

Name :

Class:.....

Grammar

❖ Choose the best answer to fill in the blank in each question.

- You _____ stop at the traffic lights. 3 Marks
 a. a. mustn't b. must c. are must d. is must
- You _____ eat when you're driving.
 a. shouldn't b. is should c. are shouldn't d. should
- Ali is a slow runner. He runs _____.
 a. is slow b. are slowly c. slowly d. slow

❖ Report the requests and commands.

- "Can you help me?" my mother asked me. My mother _____ her.
- "Turn right," said Omar to his brother. Omar _____ right.
- "Don't be late," said their parents. Their parents _____ late.



Vocabulary

❖ Choose the best answer to fill in the blank in each question.

- The _____ turns the car on. 3 Marks
 a. ignition b. headlight c. signal light d. GPS
- The _____ stops the car.
 a. trunk b. glove compartment c. brake pedal d. bumper
- Rearview _____ .
 a. wheel b. shield c. belt d. mirror

❖ Match.

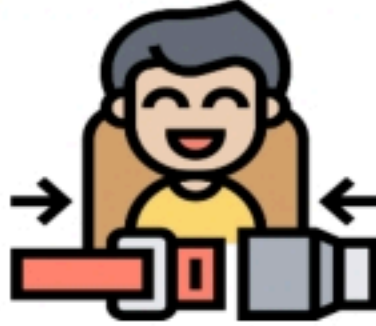
3 Marks

1	Accident	2	No Entry	3	Seat belt
A		B		C	

Orthography

❖ Choose the correct letter.

- You should drive care.....ully. 3 Marks
 a. (n) b. (f) c. (h)
- You must o.....ey the road signs.
 a. (b) b. (v) c. (m)
- You must be 18 to get a li.....ense.
 a. (a) b. (g) c. (c)

Name :

Class:

Grammar

❖ Choose the best answer to fill in the blank in each question.

1. You _____ stop at the traffic lights.

- a. a. mustn't b. **must** c. are must d. is must

3 Marks

2. You _____ eat when you're driving.

- a. **shouldn't** b. is should c. are shouldn't d. should

3. Ali is a slow runner. He runs _____.

- a. is slow b. are slowly c. **slowly** d. slow



3 Marks

❖ Report the requests and commands.

1. "Can you help me?" my mother asked me.

My mother **asked me to help** her.

2. "Turn right," said Omar to his brother.

Omar **told his brother to turn** right.

3. "Don't be late," said their parents.

Their parents **told them not to be** late.

Vocabulary

❖ Choose the best answer to fill in the blank in each question.

1. The _____ turns the car on.

- a. **ignition** b. headlight c. signal light d. GPS

3 Marks

2. The _____ stops the car.



- a. trunk b. glove compartment c. **brake pedal** d. bumper

3. Rearview _____.

- a. wheel b. shield c. belt d. **mirror**

❖ Match.

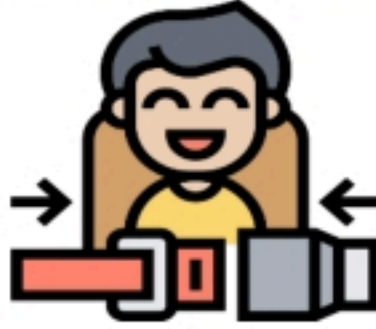
3 Marks

1	Accident	2	No Entry	3	Seat belt
A		B		C	
 No Entry Seat belt Accident

Orthography

❖ Choose the correct letter.

1. You should drive care.....ully.

- a. (n) b. **(f)** c. (h)

3 Marks

2. You must o....ey the road signs.

- a. **(b)** b. (v) c. (m)

3. You must be 18 to get a li....ense.

- a. (a) b. (g) c. **(c)**

Name :

Class :

Choose the best answer to fill in the blank.

1. dash _____

- A. shield
- B. sign
- C. wheel
- D. board

2. road _____

- A. belt
- B. sign
- C. wheel
- D. mirror

3. steering _____

- A. belt
- B. shield
- C. wheel
- D. mirror

Write the adverb of manner to fill in the blank.

1. Stan is a slow runner. He runs _____.

2. Ali is a good writer. He writes _____.

3. They are careful horseback riders. They ride their horses _____.

Rearrange the words to make a sentence.

1. the stop sign / stop / at / must / you

2. seat belt / should / you / wear / always / your

Write the reported request or command.

1. "Would you pick me up at the airport?" Dan asked his brother.

2. "Hold the steering wheel with both hands," said the driving instructor to the Ali.



A-Choose the correct answer:

- 1-You must (stop – stopping – stops) at the traffic light.
- 2-Can you (helps – helping – help) me ?
- 3- Omar drives (slow – slowly- slows) .
- 4-You shouldn't(ate – eating- eat)when you're driving.
- 5-Don't (park – parks – parking) your car there.
- 6- Saeed plays (well – will – good).

2-Do as shown between brackets.

A-(report)

1-" put your seatbelt." (father said to his children)

.....

2-"Can you make the lunch?" (my mother asked me.)

.....

B-((Give me the negative).

1-Close the window

2-raise your hand

C-Correct.

1- You mustn't talks during the test.

2- Please don't drove so fast.

D-(use adverb of manner)

1-Khalid is a good writer.....

2 They are fast runner

vocabulary

3-Match the words with their meanings

1	steering		board
2	road		sign
3	wind		wheel
4	dash		Shield



4-Choose the correct word for each picture.



(gas tank – seat belt)



(danger- stop)



(GPS-trunk)



(bumper – hood)